

VOLTECK CÓDIGO: 40018 CLAVE: PA-COAP-CLP

Placa armada contacto e interruptor Classic, VOLTECK

- Fabricado en policarbonato

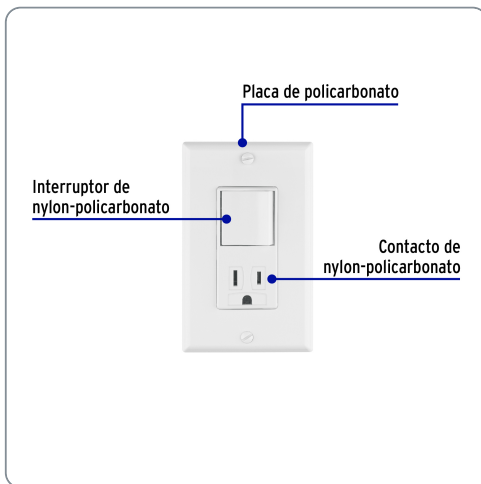

Especificaciones técnicas	
Interruptor: Tensión / Frecuencia	120 V / 60 Hz
Contacto: Tensión / Frecuencia	127 V / 60 Hz
Corriente	15 A

Datos de empaque	
Empaque individual: Bolsa	
Empaque logístico	Cantidad
Inner	3
Máster	48
Pallet	1872

Certificaciones y garantías

Cumple la norma: NOM-003-SCFI



Producto fabricado en China bajo las estrictas especificaciones de Truper

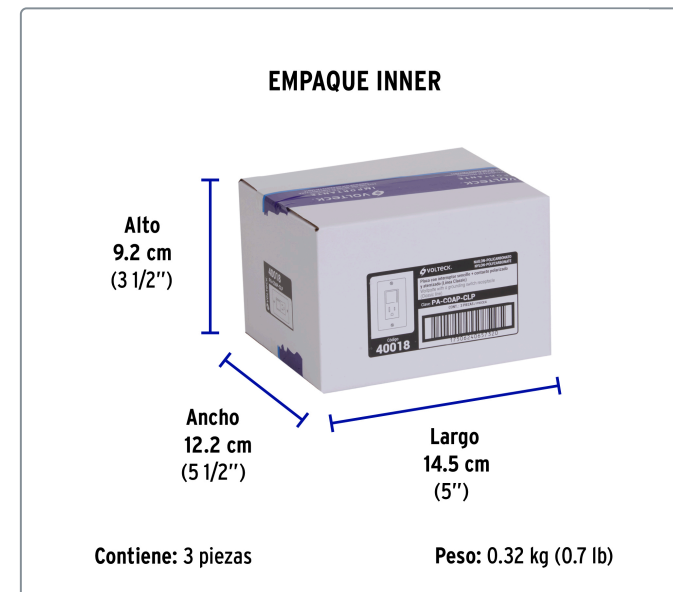
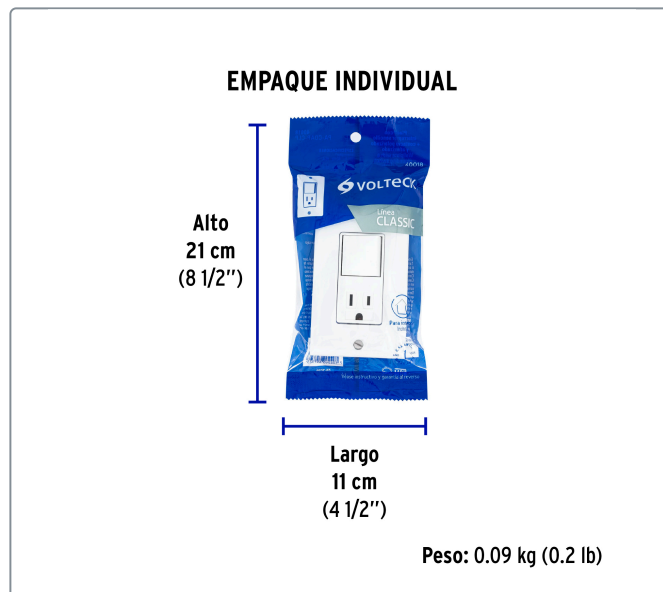
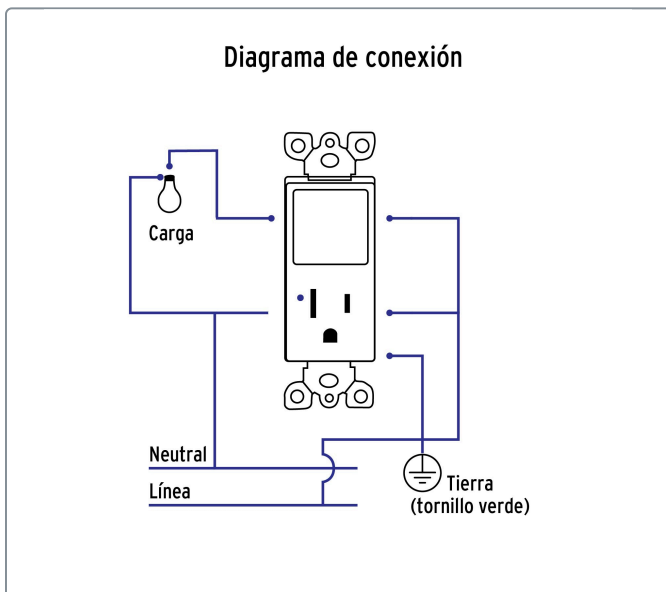
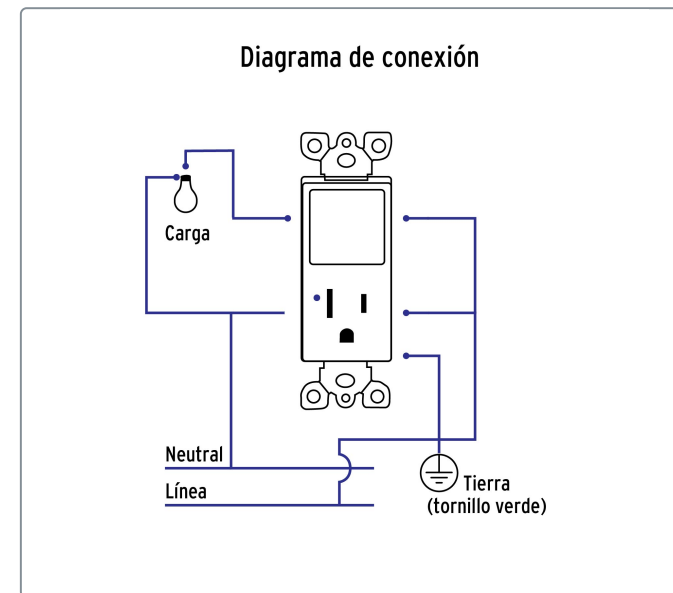
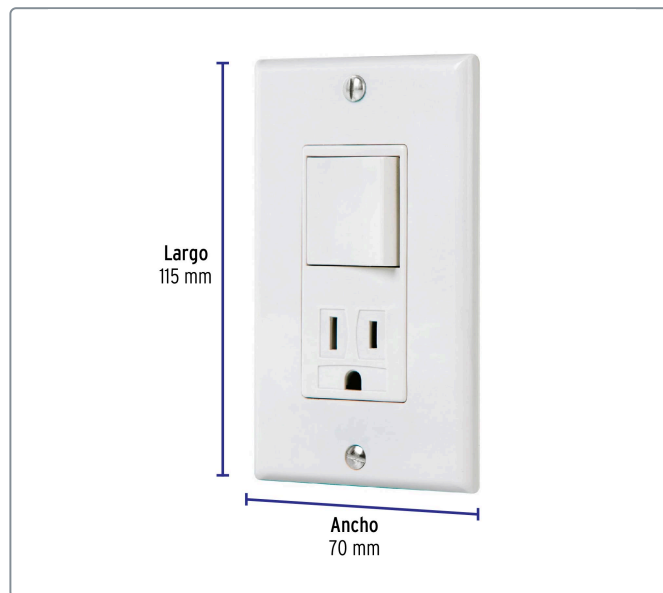
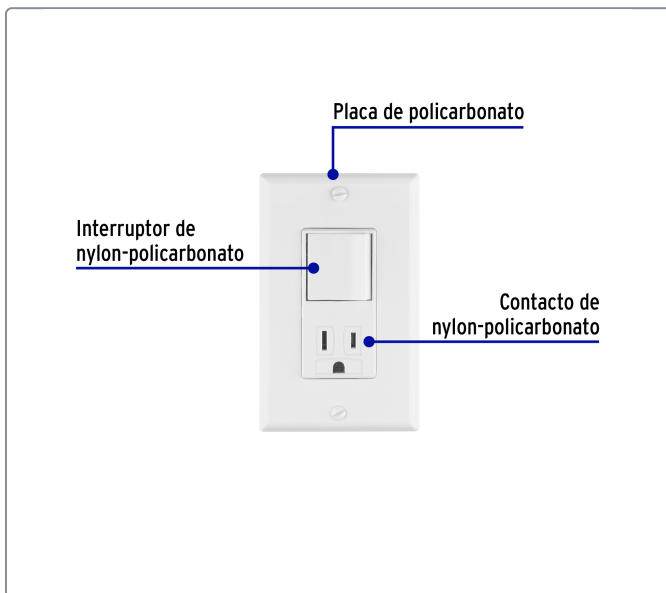

EMPAQUE MASTER



Contiene: 16 inner (48 piezas)

Peso: 5.34 kg (11.8 lb)

