

VOLTECK CÓDIGO: 48488 CLAVE: PA-CODO-S

Placa armada 2 contactos polarizados, línea Standard, marfil

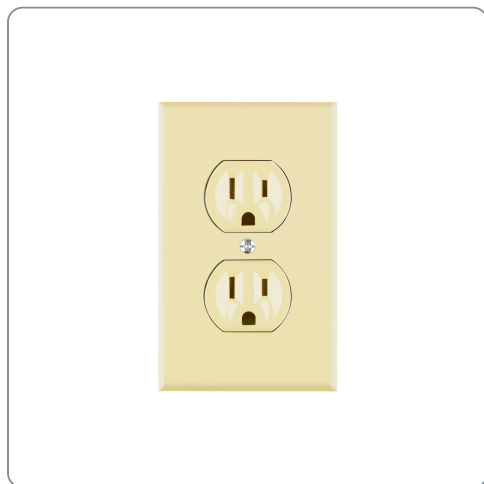

- Placa de ABS, contacto de nylon/policarbonato



Datos de empaque	
Empaque individual: Bolsa	
Empaque logístico	Cantidad
Inner	6
Máster	72
Pallet	4608

Certificaciones y garantías

Cumple la norma: NOM-003-SCFI



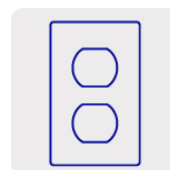

Producto fabricado en China bajo las estrictas especificaciones de Truper

Línea Standard

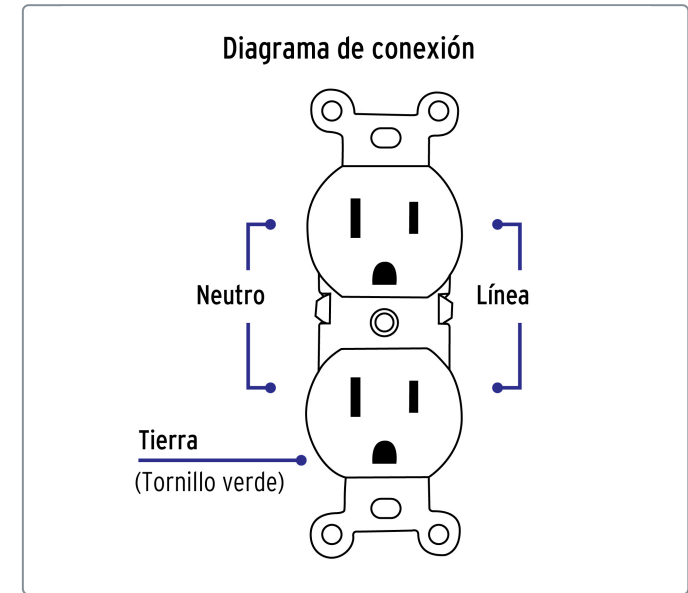
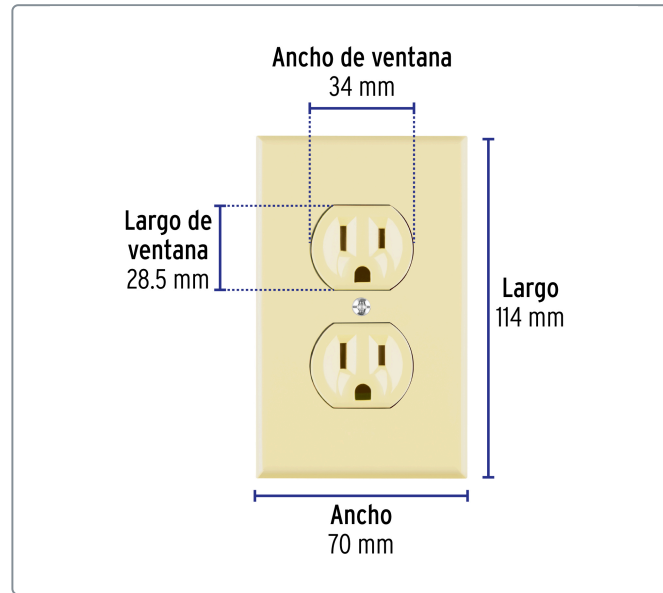
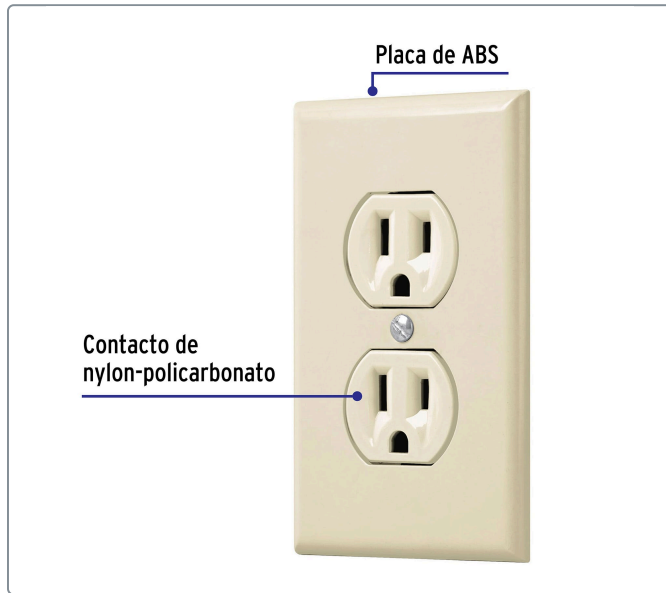

Especificaciones técnicas	
Tensión / Frecuencia	127 V / 60 Hz
Corriente	15 A



EMPAQUE INDIVIDUAL

Alto 21.5 cm (8.5")

Largo 11 cm (4.3")

Peso: 0.06 kg (0.1 lb)

EMPAQUE INNER

Alto 8.1 cm (3.2")

Ancho 13.2 cm (5.2")

Largo 15.8 cm (6.2")

Contiene: 6 piezas

Peso: 0.44 kg (1 lb)

EMPAQUE MASTER

Alto 25.5 cm (10")

Ancho 27 cm (10.6")

Largo 32.5 cm (12.8")

Contiene: 12 inner (72 piezas)

Peso: 5.56 kg (12.3 lb)

